

Faktor 4



KIM 44 Profi

flexible usage

page 13

KIM 46

skinny mini

page 14-15

KIM 55

resilient and light

page 16-17

KIM 4x4

quadratic and practical

page 18-21

KIM 5x7

robust and variable

page 22-25



Shoring elements custom-made



KIM 7x9

extra anchor
points

page 26

SAM

safe, quick
and reliable

page 28-31

PAT

variable to
meet the
highest demands

page 32-35

KAT

wide range
blocking capacity

page 36-43

Decking beams

with higher
loading capacity

page 44-49





KIM – Shoring poles custom-made

Which KIM for which application:



KIM 44 Profi

flexible usage

- red locking knob ▶ lightening-fast adjustment
- long telescope ▶ large adjustment range
- spring-loaded on top for vertical use ▶ user-friendly

KIM 46

skinny mini

- configurable ▶ suitable for all current vehicle and types of tracks
- with pull step ▶ ergonomical handling
- available with protective sleeve ▶ avoids damages to goods

KIM 55

resilient and light

- ergonomic operating lever ▶ for easy clamping and release
- telescope function ▶ only one crossbar required for all positions within the vehicle
- horizontal installation possible ▶ maximum flexibility





KIM – Shoring poles custom-made

Which KIM for which application:



KIM 4x4

quadratic and practical

- configurable ▶ suitable for all current vehicle and types of tracks
- anti-twist bolt ▶ for flexible use in Airline and roundhole tracks
- New Airline insert ▶ allows for many different possibilities

KIM 5x7

robust and variable

- high-strength squared aluminum main tube ▶ more blocking force to meet the highest expectations
- longer floor bolt ▶ for levering loads
- main tube with integrated Airline milling ▶ stronger building blocks
- anti-twist fixation at top ▶ also fits in round hole tracks
- profi hand grip ▶ ergonomic and safe

KIM 7x9

strong and removable

- very robust ▶ for continuous loading and unloading
- ergonomically adjustable ▶ little physical strain

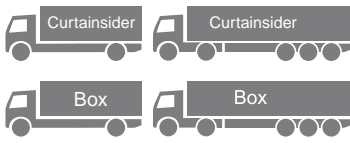
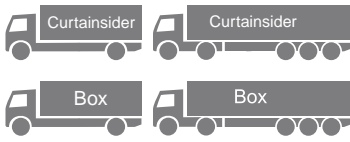

Your customized KIM. Compose it yourself:



▶ Total length



Configure your KIM for your vehicle. We produce your KIM to fit your exact internal dimensions.

▶ Adjustment range (only with KIM Profi)



KIM Profi has a large adjustment range, meaning that it can be used horizontally or vertically. It can also be used in vehicles with various interior dimensions. With just one look at the telescope insert you can tell which blocking force applies for your current working length. The new lever mechanism allows for a very ergonomic fitting and removal.



▶ End pieces



KIMs can be configured with 19 or 24 Ø mm slotted or solid bolts which fit perfectly in 20 or 25 Ø mm Airline or round hole tracks. Slots are also compatible with pin tracks.

▶ Load protection



Accessories for preventing damage to fragile goods. KIM 46 and KIM 46 Profi can be configured with a protection sleeve which is mounted during production.

▶ Product identification sticker

| BC | 12-12 | 12-12 |
|----------|-------|-------|
| 900 daN | • | • |
| 1200 daN | • | • |
| 1500 daN | • | • |

Stößensicherheiten BC = 80%

All KIMs are supplied with a certified load capacity specification on our product labels. Another one of our top standards is our QR Code which shows all important information about your Faktor-4 product. Use the allsafe-app to easily proof, calculate and manage your allsafe products.

▶ all:change

KIM is covered by our all:change-promise. That means we maintain and repair damaged or worn-out KIM for a fixed price. Annual safety check, pick-up and delivery are included.

KIM 44 Profi



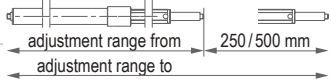

Variable length and Ø 44 mm. Ideal for vertical use.

Length Weight: approx 2,5 – 4,0 kg depending on length

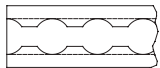
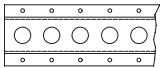

| 1 - Adjustment range | 2 - End pieces | 3 - Load protection | 4 - Product identification sticker | Order code |
|--|----------------|---------------------|--|--|
| Adjustment lengths from min. 650 to max.1049 mm: 250 mm adjustment range. Adjustment lengths from min. 1050 to max. 2500 mm: 500 mm adjustment range. | | |  | 511110 KIM 44 Profi xxxx - xxxx mm |
| Adjustment range from xxxx - xxxx needed by order. | | | | |

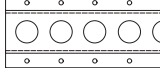

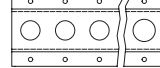
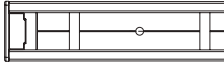
▶ Upper / Lower end pieces

| ✓ | 2 - End pieces | 3 - Load protection | 4 - Product identification sticker | Order code |
|---|---|---|--|-----------------|
|  |  |  | | Bolt D 19 short |
| Bolzen Ø 19 mm kurz | Compatible with Airline and round hole tracks Ø 20 mm | | | |
|  |  |  | | Bolt D 24 short |
| Bolzen Ø 24 mm kurz | Compatible with Airline and round hole tracks Ø 25 mm | | | |
| ✓ | 2 - End pieces | 3 - Load protection | 4 - Product identification sticker | Order code |
|  |  |  |  | Slot D 19 |
| Slot Ø 19 mm | Compatible with Airline, round hole Ø 20/25 mm and pin tracks Ø 8 mm | | | |

▶ Load protection and park holder

| ✓ | ✓ | 3 - Load protection | 4 - Product identification sticker | Order code |
|--|---|---------------------|------------------------------------|------------|
|  | | | | |
| Protection sleeve | | | | Sleeve |

▶ Customized product identification sticker

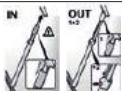
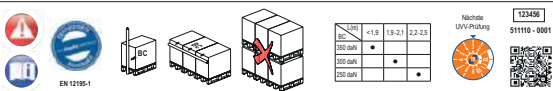
| ✓ | ✓ | ✓ | 4 - Product identification sticker | Order code |
|---|---|---|--|-----------------|
|  |  |  |  | |
| Customized product label with your logo | | | | Custom sticker |
| Product label | | | | allsafe sticker |

▶ Sample order code

KIM 44 Profi - 1550-2050 - Bolzen D 19 - allsafe sticker - Sleeve



Accessories

| | |
|---|----------------------|
|  | Park holder 510479x3 |
|---|----------------------|



FAKTOR 4

KIM 46

Light-weight with 320 daN blocking capacity*.





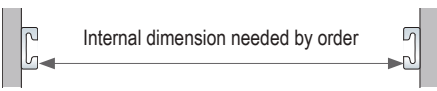



► **Length** Weight: approx 1,5 – 3,5 kg depending on length



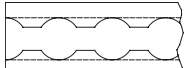
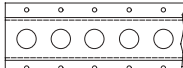

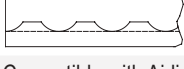

| 1 - Length | 2 - End pieces | 3 - Pull strap | 4 - Load protection | 5 - Product identification sticker | Order code |
|--|----------------|----------------|---------------------|------------------------------------|-------------------------------|
| Adjustment range possible from min. 640 to max. 2520 mm, with a fixed 70 mm range of spring. | | | | | 512078 KIM 46 |
|   | | | | | Internal dimension xxxx mm |

* up to 780 mm length 900 daN; from 780-1200 mm length 700 daN; von 1200-2000 mm length 320 daN; from 2000 mm length 200 daN

► **Upper / Lower end pieces**

| ✓ | 2 - End pieces | 3 - Pull strap | 4 - Load protection | 5 - Product identification sticker | Order code |
|---|---|---|---|---|-----------------------------------|
|  |  |  |  |  | Bolt D 19 short Bolt D 19 long |
| Bolt Ø 19 mm short Bolt Ø 19 mm long | | | Compatible with Airline and round hole tracks Ø 20 mm | | |
|  |  |  |  |  | Bolt D 24 short Bolt D 24 long |
| Bolt Ø 24 mm short Bolt Ø 24 mm long | | | Compatible with Airline and round hole tracks Ø 25 mm | | |

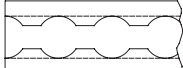
For sidewall and roof tracks, we recommend short bolts

| ✓ | 2 - End pieces | 3 - Pull strap | 4 - Load protection | 5 - Product identification sticker | Order code |
|---|---|---|--|---|------------------------|
|  |  |  |  |  | Slot D 19 Slot D 24 |
| Slot Ø 19 mm Slot Ø 24 mm | | Compatible with Airline, round hole Ø 20/25 mm and pin tracks Ø 8/10 mm | | | |

► **Pull strap for vertical use**

| ✓ | ✓ | 3 - Pull strap | 4 - Load protection | 5 - Product identification sticker | Order code |
|---|---|----------------|---------------------|------------------------------------|---------------|
|  | | | | | Pull strap |
| With / without pull strap | | | | | Without strap |

► **Load protection**

| ✓ | ✓ | ✓ | 4 - Load protection | 5 - Product identification sticker | Order code |
|--|---|---|---------------------|------------------------------------|------------|
|  | | | | | Sleeve |
| Protection sleeve | | | | | |

► **Customized product identification sticker**

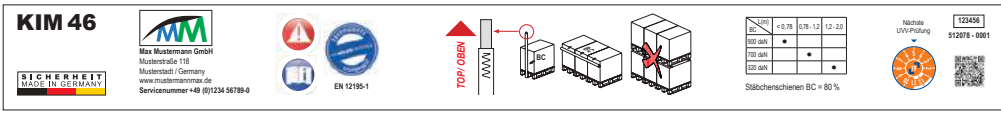
| ✓ | ✓ | ✓ | ✓ | 5 - Product identification sticker | Order code |
|--|---|---|---|------------------------------------|-----------------|
|  | | | | | Custom sticker |
| Customized product label with your logo | | | | | allsafe sticker |
| Product label | | | | | |

► **Sample order code**

KIM 46 - 2400 - Upper Bolt D19 short - Lower Bolt D19 long - Sleeve - allsafe sticker



KIM 46 Profi





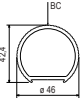
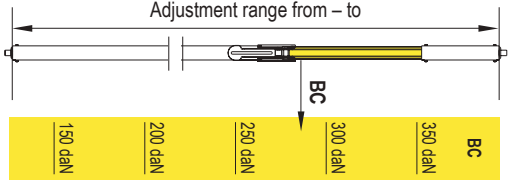
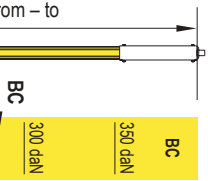

Blocking capacity of 350 daN with variable lengths.

► **Length** Weight: approx 2,3 – 4,0 kg depending on length



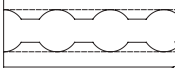
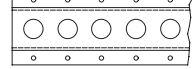

| 1 - Length | 2 - End pieces | 3 - Load protection | 4 - Product identification sticker | Order code |
|---------------------------------|---|--|--|------------|
| Adjustment range 1150 – 1550 mm |  |  |  | 512076 |
| Adjustment range 1550 – 2050 mm | | | | KIM 46 |
| Adjustment range 2000 – 2500 mm | | | | Profi |
| | | | | xxxx mm |

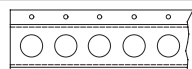
► **Upper / Lower end pieces**

| ✓ | 2 - End pieces | 3 - Load protection | 4 - Product identification sticker | Order code |
|---|--|---|--|-----------------------------------|
|  Bolt Ø 19 mm short |  Bolt Ø 19 mm long |  |  | Bolt D 19 short Bolt D 19 long |
|  Bolt Ø 24 mm short |  Bolt Ø 24 mm long |  |  | Bolt D 24 short Bolt D 24 long |



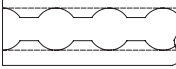
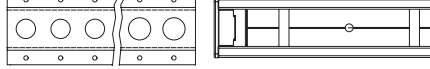

For sidewall and roof tracks, we recommend short bolts

| ✓ | 2 - End pieces | 3 - Load protection | 4 - Product identification sticker | Order code |
|---|---|---|--|------------------------|
|  Slot Ø 19 mm |  Slot Ø 24 mm |  |  | Slot D 19 Slot D 24 |

► **Load protection**

| ✓ | ✓ | 3 - Load protection | 4 - Product identification sticker | Order code |
|--|---|---------------------|------------------------------------|------------|
|  | | | | |
| Protection sleeve | | | | Sleeve |

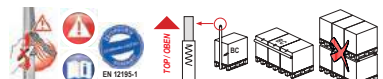
► **Customized product identification sticker**

| ✓ | ✓ | ✓ | 4 - Product identification sticker | Order code |
|---|---|---|--|-----------------|
|  |  |  |  | |
| Customized product label with your logo | | | | Custom sticker |
| Product label | | | | allsafe sticker |

► **Sample order code**

KIM 46 Profi - 1550-2050 - Upper Bolt D19 short - Lower Bolt D19 long - allsafe sticker



FAKTOR 4

KIM 55

Light-weight with up to 450 daN* blocking capacity.





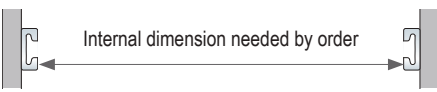

► **Length** Weight: approx 2,5 – 3,8 kg depending on length



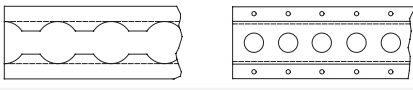
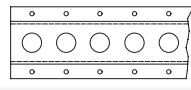

| 1 - Length | 2 - End pieces | 3 - Pull strap | 4 - Product identification sticker | Order code |
|--|--|----------------|------------------------------------|-------------------------------|
| Adjustment range possible from min. 640 to max. 2520 mm, with a fixed 70 mm range of spring. | | | | 512075 KIM 55 |
|  |  | | | Internal dimension xxxx mm |

* from 2000 mm length 350 daN

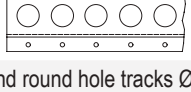
► **Upper / Lower end pieces**

| ✓ | 2 - End pieces | 3 - Pull strap | 4 - Product identification sticker | Order code |
|---|---|--|---|-----------------------------------|
|  |  |  |  | Bolt D 19 short Bolt D 19 long |
|  |  |  |  | Bolt D 24 short Bolt D 24 long |

For sidewall and roof tracks, we recommend short bolts

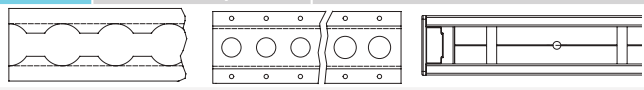
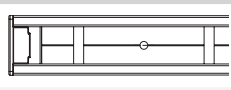
| ✓ | 2 - End pieces | 3 - Pull strap | 4 - Product identification sticker | Order code |
|---|---|--|---|------------------------|
|  |  |  |  | Slot D 19 Slot D 24 |

► **Pull strap for vertical use**

| ✓ | ✓ | 3 - Pull strap | 4 - Product identification sticker | Order code |
|---|---|----------------|------------------------------------|---------------|
|  | | | | Pull strap |
| With / without pull strap | | | | Without strap |

► **Customized product identification sticker**

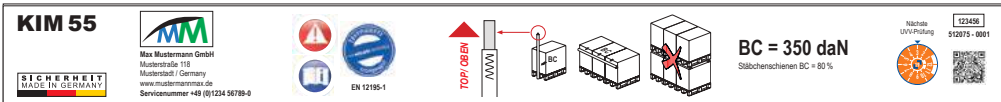
| ✓ | ✓ | ✓ | 4 - Product identification sticker | Order code |
|--|---|---|------------------------------------|-----------------|
|  | | | | |
| Customized product label with your logo | | | | Custom sticker |
| Product label | | | | allsafe sticker |

► **Sample order code**

KIM 55 - 2400 - Upper Bolt D19 short - Lower Bolt D19 long - without strap - allsafe sticker





KIM 55 Profi





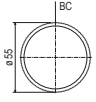
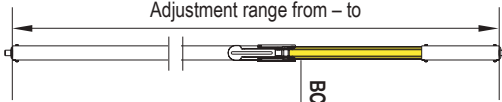

Blocking capacity of 500 daN with variable lengths.

▶ **Length** Weight: approx 4,0 – 5,0 kg depending on length



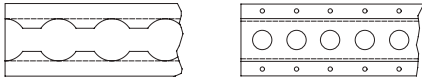
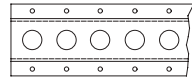

| 1 - Length | 2 - End pieces | 3 - Product identification sticker | Order code |
|---------------------------------|---|--|------------|
| Adjustment range 1850 – 2300 mm |  |  | 512073 |
| Adjustment range 2100 – 2550 mm | | | KIM 55 |
| Adjustment range 2400 – 2850 mm | | | Profi |
| | |  | xxxx mm |

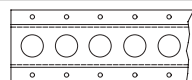
▶ Upper / Lower end pieces

| 1 - End pieces | 2 - End pieces | 3 - Product identification sticker | Order code |
|---|--|--|-----------------------------------|
|   |  |  | Bolt D 19 short Bolt D 19 long |
| Bolt Ø 19 mm short Bolt Ø 19 mm long | Compatible with Airline and round hole tracks Ø 20 mm | | |
|   |  |  | Bolt D 24 short Bolt D 24 long |
| Bolt Ø 24 mm short Bolt Ø 24 mm long | Compatible with Airline and round hole tracks Ø 25 mm | | |

For sidewall and roof tracks, we recommend short bolts

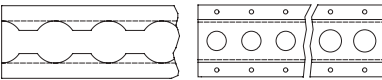
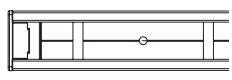
| 1 - End pieces | 2 - End pieces | 3 - Product identification sticker | Order code |
|---|---|--|------------------------|
|   |  |  | Slot D 19 Slot D 24 |
| Slot Ø 19 mm Slot Ø 24 mm | Compatible with Airline, round hole Ø 20/25 mm and pin tracks Ø 8/10 mm | | |

▶ Customized product identification sticker

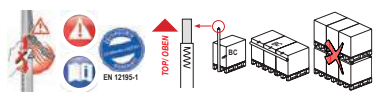
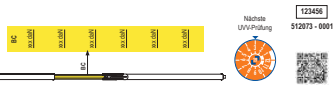
| 1 - End pieces | 2 - End pieces | 3 - Product identification sticker | Order code |
|---|---|--|-----------------------------------|
|  |  |  | Custom sticker allsafe sticker |
| Customized product label with your logo | Product label | | |

▶ Sample order code

KIM 55 Profi - 2100-2550 - Upper Bolt D 19 short - Lower Bolt D 19 long - allsafe sticker



FAKTOR 4

KIM 4x4

Light-weight with 400 daN blocking capacity*.



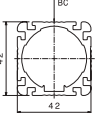
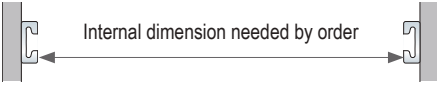

► **Length** Weight: approx 2,5 – 4,0 kg depending on length



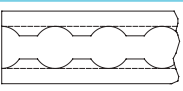
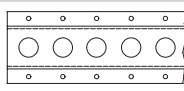

| 1 - Length | 2 - End pieces | 3 - Pull Strap | 4 - Product identification sticker | Order code |
|--|----------------|----------------|------------------------------------|-------------------------------|
| Adjustment range possible from min. 640 to max. 2520 mm, with a fixed 70 mm range of spring. | | | | 512082 |
|   | | | | KIM 4x4 |
| | | | | Internal dimension xxxx mm |

* up to 780 mm length 750 daN; from 2000 mm length 300 daN

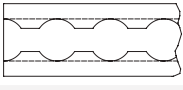
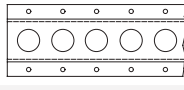
► **Upper / Lower end pieces**

| ✓ | 2 - End pieces | 3 - Pull Strap | 4 - Product identification sticker | Order code |
|---|---|---|---|-----------------------------------|
|  |  |  |  | Bolt D 19 short Bolt D 19 long |
|  |  |  |  | Bolt D 24 short Bolt D 24 long |

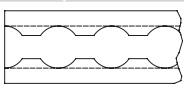

For sidewall and roof tracks, we recommend short bolts

| ✓ | 2 - End pieces | 3 - Pull strap | 4 - Product identification sticker | Order code |
|---|---|--|------------------------------------|----------------------------|
|  |  |  | | Bolt X-axis Bolt Y-axis |
| Anti-twist X (Standard) | Anti-twist Y | Compatible with Airline tracks | | |

► **Pull strap for vertical use**

| ✓ | ✓ | 3 - Pull Strap | 4 - Product identification sticker | Order code |
|---|---|----------------|------------------------------------|------------|
|  | | | | |
| With pull strap | | | | Pull strap |

► **Customized product identification sticker**

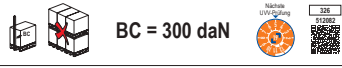
| ✓ | ✓ | ✓ | 4 - Product identification sticker | Order code |
|---|---|---|--|-----------------|
|  |  |  |  | |
| Customized product label with your logo | | | | Custom sticker |
| Product label | | | | allsafe sticker |

► **Sample order code**

KIM 4x4 - 2400 - Upper Bolt D 19 short - Lower Bolt D 19 long - allsafe sticker



NEW!

Accessories

| | |
|---|------------------------|
|  | Airline adapter 512144 |
|---|------------------------|

KIM 4x4 Profi

Blocking capacity of 400 daN with variable lengths.

► **Length** Weight: approx 3,0 – 5,0 kg depending on length



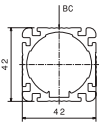
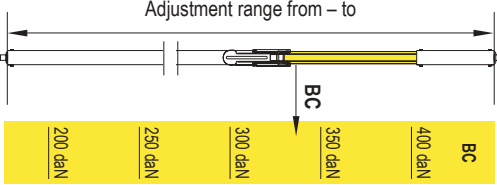

| 1 - Length | 2 - End pieces | 3 - Product identification sticker | Order code |
|---------------------------------|---|--|---------------------------------------|
| Adjustment range 1250 – 1650 mm |  |  | 512080 KIM 4x4 Profi xxxx mm |
| Adjustment range 1500 – 1950 mm | | | |
| Adjustment range 1850 – 2300 mm | | | |
| Adjustment range 2100 – 2550 mm | | | |

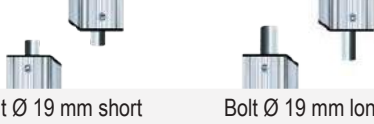
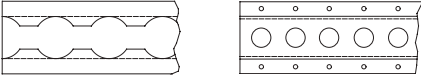
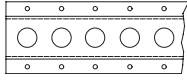
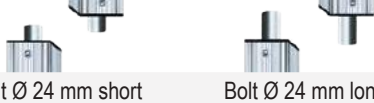
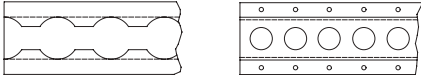
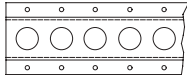

► **Upper / Lower end pieces**

| ✓ | 2 - End pieces | 3 - Product identification sticker | Order code | |
|--|--|---|---|-----------------------------------|
|  |  |  | Bolt D 19 short Bolt D 19 long | |
|  | | | | |
| Bolt Ø 24 mm short Bolt Ø 24 mm long | |  |  | Bolt D 24 short Bolt D 24 long |

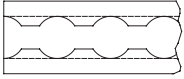
For sidewall and roof tracks, we recommend short bolts

| ✓ | 2 - End pieces | 3 - Product identification sticker | Order code |
|---|---|---|----------------------------|
|  |  |  | Bolt X-axis Bolt Y-axis |
| Anti-twist X (Standard) | Anti-twist Y | Compatible with Airline tracks | |

► **Customized product identification sticker**

| ✓ | ✓ | 3 - Product identification sticker | Order code |
|---|---|--|-----------------------------------|
|  |  |  | Custom sticker allsafe sticker |
| Customized product label with your logo | Product label | | |

► **Sample order code**

KIM 4x4 Profi - 2100-2550 - Upper Bolt D 19 short - Lower Bolt D 19 long - allsafe sticker



NEW!

Accessories

| | |
|---|------------------------|
|  | Airline adapter 512144 |
|---|------------------------|



FAKTOR 4

KIM 4x4 Airline

Light-weight with 400 daN blocking capacity*.



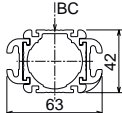
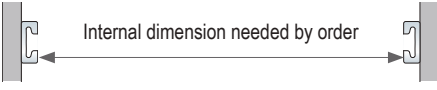

► **Length** Weight: approx 3,0 – 7,0 kg depending on length



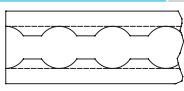
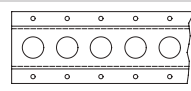

| 1 - Length | 2 - End pieces | 3 - Pull strap | 4 - Product identification sticker | Order code |
|--|----------------|----------------|------------------------------------|---|
| Adjustment range possible from min. 640 to max. 2520 mm, with a fixed 70 mm range of spring. | | | | 512083 |
|   | | | | KIM 4x4 Airline Internal dimension xxxx mm |

* up to 780 mm length 750 daN; from 2000 mm length 300 daN

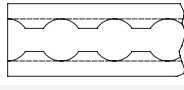
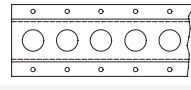
► **Upper / Lower end pieces**

| ✓ | 2 - Endstücke | 3 - Pull strap | 4 - Product identification sticker | Order code |
|---|---|---|---|-----------------------------------|
|  |  |  |  | Bolt D 19 short Bolt D 19 long |
|  |  |  |  | Bolt D 24 short Bolt D 24 long |

For sidewall and roof tracks, we recommend short bolts

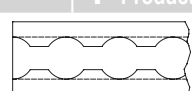
| ✓ | 2 - End pieces | 3 - Pull strap | 4 - Product identification sticker | Order code |
|---|---|--|------------------------------------|----------------------------|
|  |  |  | | Bolt X-axis Bolt Y-axis |
| Anti-twist X (Standard) | Anti-twist Y | Compatible with Airline tracks | | |

► **Pull strap for vertical use**

| ✓ | ✓ | 3 - Pull strap | 4 - Product identification sticker | Order code |
|---|---|----------------|------------------------------------|------------|
|  | | | | |
| With pull strap | | | | Pull strap |

► **Customized product identification sticker**

| ✓ | ✓ | ✓ | 4 - Product identification sticker | Order code |
|--|---|---|------------------------------------|-----------------|
|  | | | | Custom sticker |
| Product label | | | | allsafe sticker |

► **Sample order code**

KIM 4x4 Airline - 2400 - Upper Bolt D 19 short - Lower Bolt D 19 long - allsafe sticker



Accessories

| | |
|---|------------------------|
|  | Airline adapter 512144 |
|---|------------------------|

KIM 4x4 Airline Profi





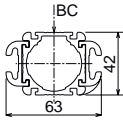
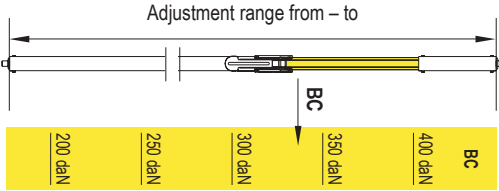

Blocking capacity of 400 daN with variable lengths.

► **Length** Weight: approx 3,0 – 7,0 kg depending on length



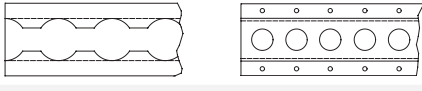

| 1 - Length | 2 - End pieces | 3 - Product identification sticker | Order code |
|---------------------------------|---|--|---|
| Adjustment range 1250 – 1650 mm |  |  | 512081 KIM 4x4 Airline Profi xxxx mm |
| Adjustment range 1500 – 1950 mm | | | |
| Adjustment range 1850 – 2300 mm | | | |
| Adjustment range 2100 – 2550 mm | | | |



► **Upper / Lower end pieces**

| ✓ | 2 - End pieces | 3 - Product identification sticker | Order code |
|--|---|--|-----------------------------------|
|  Bolt Ø 19 mm short |  Bolt Ø 19 mm long |  Compatible with Airline and round hole tracks Ø 20 mm | Bolt D 19 short Bolt D 19 long |
|  Bolt Ø 24 mm short |  Bolt Ø 24 mm long |  Compatible with Airline and round hole tracks Ø 25 mm | |

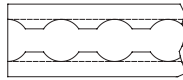
For sidewall and roof tracks, we recommend short bolts

| ✓ | 2 - End pieces | 3 - Product identification sticker | Order code |
|--|---|---|----------------------------|
|  Anti-twist X (Standard) |  Anti-twist Y |  Compatible with Airline tracks | Bolt X-axis Bolt Y-axis |

► **Customized product identification sticker**

| ✓ | ✓ | 3 - Product identification sticker | Order code |
|--|--|---|-----------------------------------|
|  Customized product label with your logo |  Product label |  allsafe sticker | Custom sticker allsafe sticker |

► **Sample order code**

KIM 4x4 Airline Profi - 2100-2550 - Upper Bolt D19 short - Lower Bolt D19 long - allsafe sticker



NEW!

Accessories

| | |
|---|------------------------|
|  | Airline adapter 512144 |
|---|------------------------|



FAKTOR 4

1.1 Faktor 4 KIM

anti-twist fixation

KIM 5x7



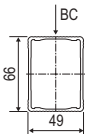
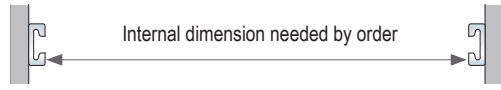

Light-weight with 750 daN blocking force.

► **Length** Weight: approx 2 – 6 kg depending on length





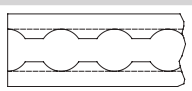

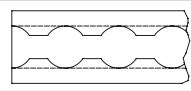
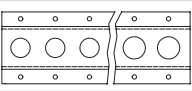
| 1 - Length | 2 - End pieces | 3 - Control element | 4 - Product identification sticker | Order code |
|--|----------------|---------------------|------------------------------------|-------------------------------|
| Adjustment range possible from min. 640 to max. 2480 mm, with a fixed 70 mm range of spring. | | | | 512061 KIM 5x7 |
|   | | | | Internal dimension xxxx mm |

► **Upper end pieces**

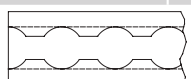
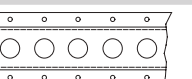

| ✓ | 2 - End pieces | 3 - Control element | 4 - Product identification sticker | Order code |
|---|---|---|---|--|
|  |  |  |  | Roof track Bolt X-axis Bolt Y-axis |
| Roof track (522020) | Anti-twist X (Standard) | Anti-twist Y | Compatible with Airline tracks Ø 20 mm | |
|  |  |  |  | Bolt D 19 short Bolt D 24 short |
| Bolt Ø 19 mm short | Bolt Ø 24 mm short | Compatible with Airline and round hole tracks Ø 20 / 25 mm | | |

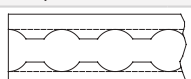
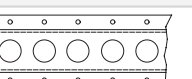
► **Lower end pieces**









| ✓ | 2 - End pieces | 3 - Control element | 4 - Product identification sticker | Order code |
|---|---|---|---|-----------------------------------|
|  |  |  |  | Bolt D 19 long Bolt D 19 short |
| Bolt Ø 19 mm long | Bolt Ø 19 mm short | Compatible with Airline and round hole tracks Ø 20 mm | | |
|  |  |  |  | Bolt D 24 long Bolt D 24 short |
| Bolt Ø 24 mm long | Bolt Ø 24 mm short | Compatible with Airline and round hole tracks Ø 25 mm | | |

For sidewall and roof tracks, we recommend short bolts

► **Handle for a better handling / accessories**

| ✓ | ✓ | 3 - Control element | 4 - Product identification sticker | Order code |
|---|---|---|------------------------------------|-------------------------------------|
|  |  |  | | Handle Pull strap Beam holder |
| With handle | With pull strap | | Beam holder | |

► **Customized product identification sticker**

| ✓ | ✓ | ✓ | 4 - Product identification sticker | Order code |
|---|---|---|---|-----------------|
|  |  |  |  | |
|  |  |  |  | |
| Customized product label with your logo | | | | Custom sticker |
| Product label | | | | allsafe sticker |

► **Sample order code**

KIM 5x7 - 2400 - Upper bolt Ø 19 short - Lower bolt Ø 19 long - allsafe-sticker



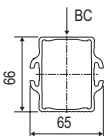
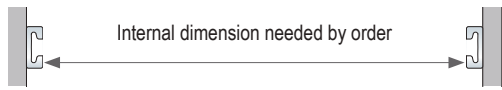

KIM 5x7 Airline

The ultimate upgrade with Airline milling.



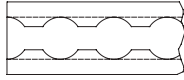

► **Length** Weight: approx 2,5 – 6,6 kg depending on length    

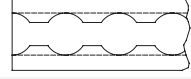
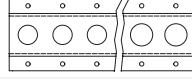
| 1 - Length | 2 - End pieces | 3 - Control element | 4 - Product identification sticker | Order code |
|---|----------------|---------------------|------------------------------------|-------------------------------|
| Adjustment range possible from min. 640 to max. 2480 mm, with a fixed 70 mm range of spring. | | | | 510574 KIM 5x7 Airline |
|   | | | | Internal dimension xxxx mm |

► Upper end pieces

| ✓ | 2 - End pieces | 3 - Control element | 4 - Product identification sticker | Order code |
|---|---|---|--|---|
|  |  |  |  | Roof track (522020) Bolt X-axis Bolt Y-axis |
|  |  |  |  | Bolt D 19 short Bolt D 24 short |

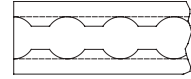
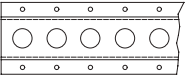
► Lower end pieces

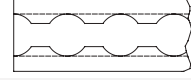
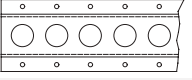



| ✓ | 2 - End pieces | 3 - Control element | 4 - Product identification sticker | Order code |
|---|---|---|--|-----------------------------------|
|  |  |  |  | Bolt D 19 long Bolt D 19 short |
|  |  |  |  | Bolt D 24 long Bolt D 24 short |

For sidewall and roof tracks, we recommend short bolts

► Handle for a better handling / accessories

| ✓ | ✓ | 3 - Control element | 4 - Product identification sticker | Order code |
|---|---|---|---|--|
|  |  |  |  | Handle Pull strap Blocking handle Beam holder |

► Customized product identification sticker

| ✓ | ✓ | ✓ | 4 - Product identification sticker | Order code |
|---|---|---|--|-----------------|
|  |  |  |  | Custom sticker |
| Customized product label with your logo | | | | allsafe sticker |

► Sample order code

KIM 5x7 Airline - 1800 - Upper bolt Ø 19 short - Lower bolt Ø 19 long - Handle - allsafe sticker



FAKTOR 4

1.1 Faktor 4 KIM

anti-twist fixation

KIM 5x7 Profi 1000 daN with variable lengths.



► **Length** Weight: approx 6,0 – 7,2 kg depending on length



| 1 - Length | 2 - End pieces | 3 - Product identification sticker | Order code |
|---------------------------------|----------------|------------------------------------|------------------------------------|
| Adjustment range 1800 – 2000 mm | | | 512047 KIM 5x7 Profi xxxx mm |
| Adjustment range 2000 – 2500 mm | | | |
| Adjustment range 2350 – 2850 mm | | | |
| Adjustment range 2700 – 3200 mm | | | |
| | | | |

► Upper end pieces

| ✓ | 2 - End pieces | 3 - Product identification sticker | Order code |
|---|----------------|------------------------------------|------------------------------------|
| | | | Bolt X-axis Bolt Y-axis |
| | | | Bolt D 19 short Bolt D 24 short |

► Lower end pieces

| ✓ | 2 - End pieces | 3 - Product identification sticker | Order code |
|---|----------------|------------------------------------|-----------------------------------|
| | | | Bolt D 19 long Bolt D 19 short |
| | | | Bolt D 24 long Bolt D 24 short |

For sidewall and roof tracks, we recommend short bolts

► Customized product identification sticker

| ✓ | ✓ | 3 - Product identification sticker | Order code |
|---|---|------------------------------------|-----------------|
| | | | Custom sticker |
| | | | allsafe sticker |

► Sample order code

KIM 5x7 Profi - 2350-2850 - Upper bolt 19 short - Lower bolt 19 long - allsafe-sticker





KIM 5x7 Airline Profi



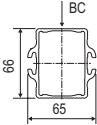
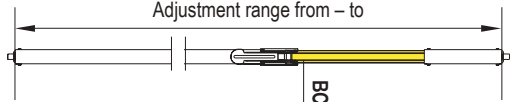

Unlimited possibilities with the highest BC.

► **Length** Weight: approx 6,2 – 7,5 kg depending on length





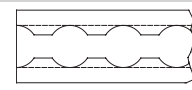

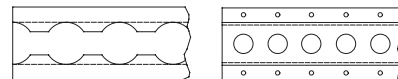
| 1 - Length | 2 - End pieces | 3 - Product identification sticker | Order code |
|---------------------------------|---|--|---|
| Adjustment range 1800 – 2000 mm |  |  | 512058 KIM 5x7 Airline Profi xxxx mm |
| Adjustment range 2000 – 2500 mm | | | |
| Adjustment range 2350 – 2850 mm | | | |
| Adjustment range 2700 – 3200 mm | | | |
| | |  | |

► **Upper end pieces**

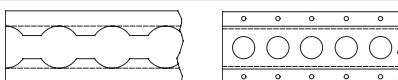

| ✓ | 2 - End pieces | 3 - Product identification sticker | Order code |
|--|--|--|------------------------------------|
|  <p>Anti-twist X (Standard)</p> |  <p>Anti-twist Y</p> |  <p>Compatible with Airline tracks</p> | Bolt X-axis Bolt Y-axis |
|  <p>Bolt Ø 19 mm short</p> |  <p>Bolt Ø 24 mm short</p> |  <p>Compatible with Airline and round hole tracks Ø 20/25 mm</p> | Bolt D 19 short Bolt D 24 short |

► **Lower end pieces**

| ✓ | 2 - End pieces | 3 - Product identification sticker | Order code |
|--|---|---|-----------------------------------|
|  <p>Bolt Ø 19 mm long</p> |  <p>Bolt Ø 19 mm short</p> |  <p>Compatible with Airline and round hole tracks Ø 20 mm</p> | Bolt D 19 long Bolt D 19 short |
|  <p>Bolt Ø 24 mm long</p> |  <p>Bolt Ø 24 mm short</p> |  <p>Compatible with Airline and round hole tracks Ø 25 mm</p> | Bolt D 24 long Bolt D 24 short |

For sidewall and roof tracks, we recommend short bolts

► **Customized product identification sticker**

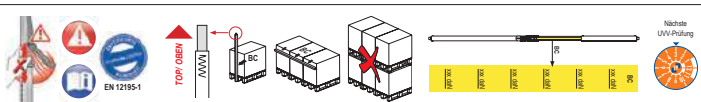
| ✓ | ✓ | 3 - Product identification sticker | Order code |
|---|---|--|-----------------------------------|
|  <p>KIM 5x7 Airline-Profi</p> <p>SICHERHEIT MADE IN GERMANY</p> |  <p>Max. Mustermann GmbH Musterstraße 110 Musterstadt / Germany www.mustermannmax.de Servicenummer +49 (0)1234 56789-0</p> |  | Custom sticker allsafe sticker |
| Customized product label with your logo | | | Custom sticker |
| Product label | | | allsafe sticker |

► **Sample order code**

KIM 5x7 Airline Profi - 1800-2300 - Upper bolt X-axis - Lower bolt 19 long - allsafe-sticker



anti-twist fixation

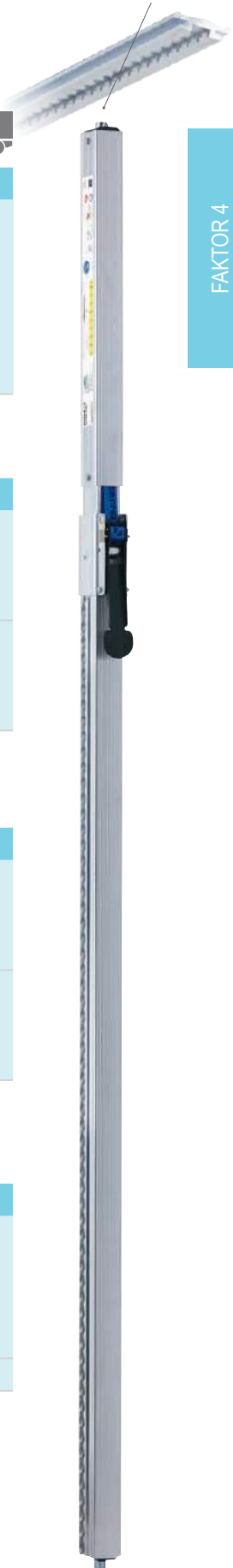

FAKTOR 4

1.1 Faktor 4 KIM

KIM 7x9

Robust positive loading, easy handling for vertical use.

► Length

Weight: approx 10 – 15 kg depending on length



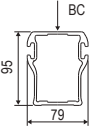

| 1 - Length | 2 - Floor track | 3 - End pieces | 4 - Product identification sticker | Order code |
|--|-----------------|----------------|------------------------------------|---|
| Adjustment range possible from min. 1800 to max. 3100 mm. Adjustment range. ± 50 mm. | | | |  |
|  | | | | |
| | | | | 512010 KIM 7x9 Internal dimension xxxx mm |

► Floor track

| ✓ | 2 - Floor track | 3 - End pieces | 4 - Product identification sticker | Order code |
|----------------------------------|-----------------|----------------|------------------------------------|--------------------|
| Please specify material by order | | | | Aluminium Steel |
| Please specify pitch by order | | | | 40 mm 50 mm |

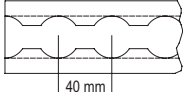
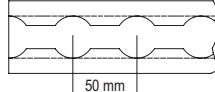
► End pieces

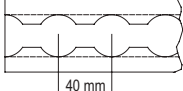
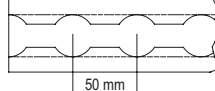
| ✓ | ✓ | 3 - End pieces | 4 - Product identification sticker | Order code |
|---|---|--|------------------------------------|------------|
|  |  |  | | Bolt 19 mm |
| Ø 19 mm bolt | Compatible with Airline tracks Ø 20 mm | | | |
|  |  |  | | Bolt 24 mm |
| Ø 24 mm bolt | Compatible with Airline tracks Ø 25 mm | | | |

► Customized product identification sticker

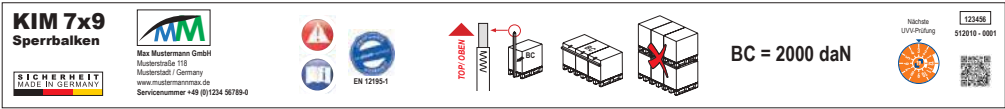
| ✓ | ✓ | ✓ | 4 - Product identification sticker | Order code |
|--|---|---|------------------------------------|-----------------|
|  | | | | Custom sticker |
| Customized product label with your logo | | | | |
| Product label | | | | allsafe sticker |

► Sample order code

KIM 7x9 - 2200 - Steel 40 mm - 19 mm bolt - allsafe sticker



Application example

KIM 5x7 Airline Profi

▶ TRS load restraint system

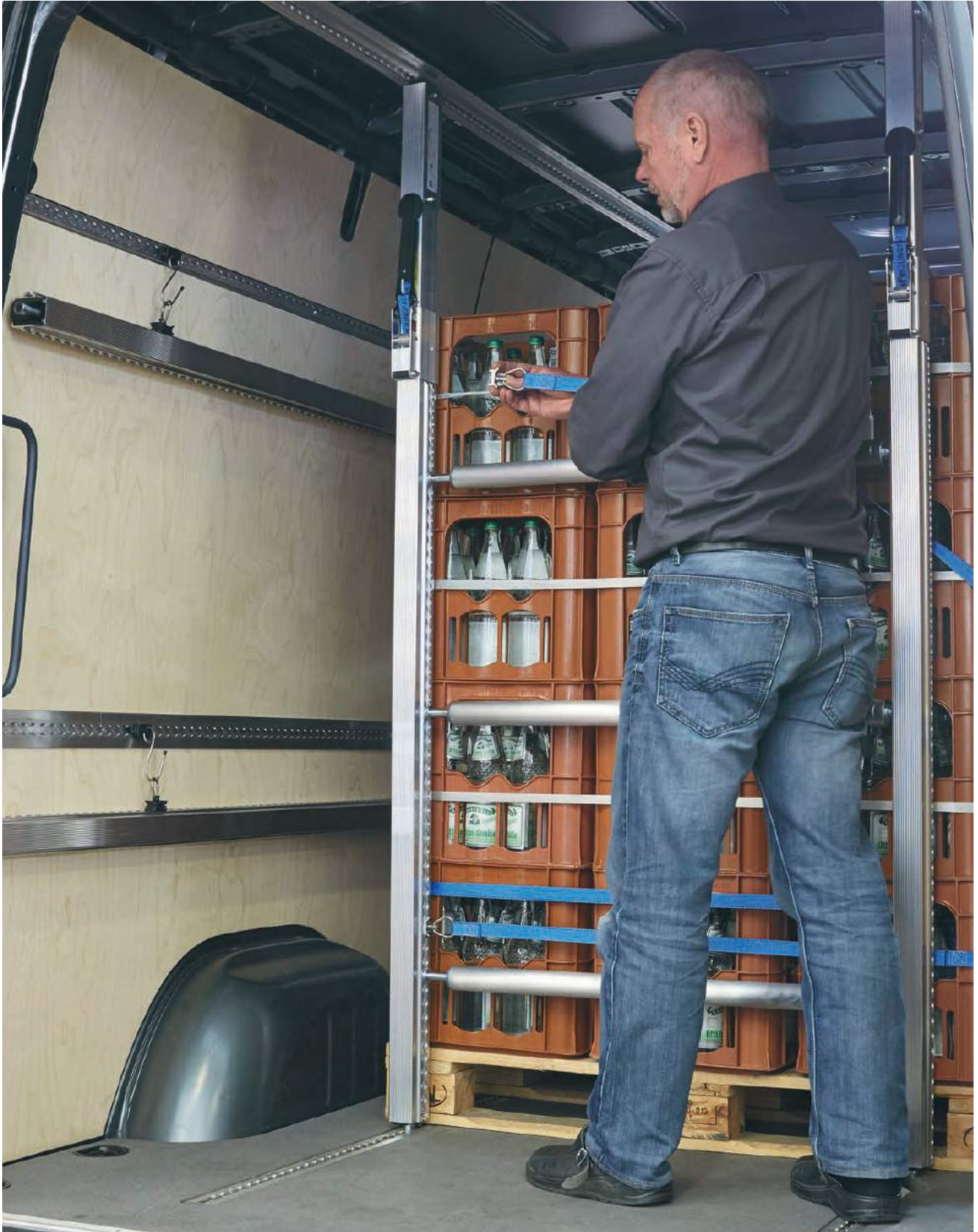

FAKTOR 4



SAM – Cargo bars custom-made

Reliable with a wide adjustment range.
Load restraint without tracks.



SAM 55 Profi

The standard for box vehicles

SAM 46 Profi

The light-weight for transporters



SAM 55 Profi



The standard for box vans.



► **Length** Weight: approx 4,0 – 5,0 kg depending on length



| 1 - Length | 2 - End pieces | 3 - Product identification sticker | Order code |
|---------------------------------|----------------|------------------------------------|--------------|
| Adjustment range 1850 – 2300 mm | | | 512074 |
| Adjustment range 2100 – 2550 mm | | | SAM 55 Profi |
| Adjustment range 2400 – 2850 mm | | | xxxx mm |

► **End pieces**

| ✓ | 2 - End pieces | 3 - Product identification sticker | Order code |
|-------------|------------------|--|--|
| | | | Upper xxx Lower xxx (Choose between rubber feet on both sides or 19 or 24 mm bolts on either side) |
| Rubber foot | Rubber foot blue | | |
| Bolt 19 mm | Bolt 24 mm | Compatible with Airline and round hole tracks Ø 20 / 25 mm | |

► **Customized product identification sticker**

| ✓ | ✓ | 3 - Product identification sticker | Order code |
|---|---|------------------------------------|-----------------|
| | | | |
| Customized product label with your logo | | | Custom sticker |
| allsafe-Produkttypenschild | | | allsafe sticker |

► **Sample order code**

SAM 55 Profi - 2100-2550 - Upper Bolt D19 - Lower Rubber foot - allsafe sticker



Need bolts on both sides?
KIM makes your wish come true!

Accessories

| | | |
|------------------------------|-------------------------|-------------------------|
| Compatible with SAM 55 Profi | | |
| | Clip on frame 512059-07 | Clip on frame 512059-12 |

SAM 46 Profi

The light-weight for transporters.



► **Length** Weight: approx 2,3 – 4,0 kg depending on length

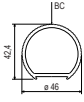



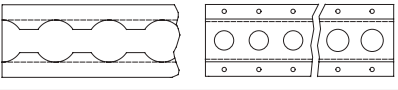

| 1 - Length | 2 - End pieces | 3 - Product identification sticker | Order code |
|----------------------------------|---|------------------------------------|------------|
| Adjustment range 1150 – 1550 mm* |  | | 512077 |
| Adjustment range 1550 – 2050 mm* | | | SAM 46 |
| Adjustment range 2000 – 2500 mm* | | | Profi |
| | | | xxxx mm |

* up to 1550 mm length 140 daN; from 1550 mm length 120 daN

► **End pieces**

| ✓ | 2 - End pieces | 3 - Product identification sticker | Order code | |
|---|--|--|------------------|--|
|  |  | | Upper xxx | |
| Rubber foot | | | Rubber foot blue | Lower xxx |
| | | | | (Choose between rubber feet on both sides or 19 or 24 mm bolts on either side) |
|  | | | | |
| Bolt 19 mm | Bolt 24 mm | Compatible with Airline and round hole tracks Ø 20 / 25 mm | | |

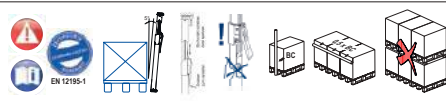
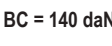
► **Customized product identification sticker**

| ✓ | ✓ | 3 - Product identification sticker | Order code |
|--|---|------------------------------------|-----------------|
|      | | | |
| Customized product label with your logo | | | Custom sticker |
| Product label | | | allsafe sticker |

► **Sample order code**

SAM 46 Profi - 1550-2050 - Upper Bolt D19 - Lower Rubber foot - allsafe sticker



*Need bolts on both sides?
KIM makes your wish come true!*

Accessories

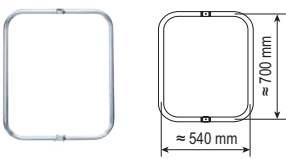
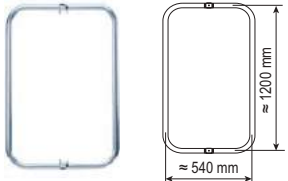
| | | |
|------------------------------|---|--|
| Compatible with SAM 46 Profi |  |  |
| | Clip on frame 512059-08 | Clip on frame 512059-13 |



FAKTOR 4



PAT – Clamp-shoring beams custom-made

Patented and unique.

PAT 1000
the strongest





1.3 Faktor 4 PAT

PAT 1000-1

One-piece beam. 1000 daN blocking capacity. For 18-35 mm side boards.







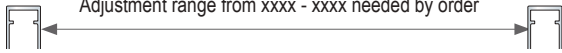
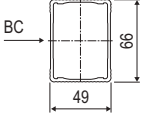



► **Length** Weight: approx 4,0 – 6,5 kg depending on length



| 1 - Adjustment range | 2 - Product identification sticker | Order code |
|--|------------------------------------|--|
| Adjustment lengths from min. 550 to max. 2520 mm: 120 mm adjustment range. | | 511023 PAT 1000-1 xxxx - xxxx mm |
| <p>Adjustment range from xxxx - xxxx needed by order</p>   | | |

► **Customized product identification sticker**

| ✓ | 2 - Product identification sticker | Order code |
|--|------------------------------------|-------------------------|
|          | | 123456 511023 - 0001 |
| Customized product label with your logo | | Custom sticker |
| Product label | | allsafe sticker |

► **Sample order code**

| | | | | |
|------------|---|-----------|---|-----------------|
| PAT 1000-1 | - | 2400-2520 | - | allsafe sticker |
|------------|---|-----------|---|-----------------|



PAT 1000-2

Two-piece beam. 1000 daN blocking capacity. For 18-35 mm side boards.







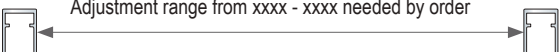
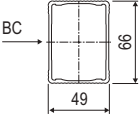



► **Length** Weight: approx 4,5 – 7,0 depending on length

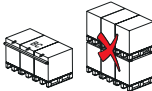

| 1 - Adjustment range | 2 - Product identification sticker | Order code |
|--|------------------------------------|--|
| Adjustment lengths from min. 1830 to max. 2520 mm: 230 mm adjustment range. | | 511024 PAT 1000-2 xxxx - xxxx mm |
| <p>Adjustment range from xxxx - xxxx needed by order</p>   | | |

► **Customized product identification sticker**

| ✓ | 2 - Product identification sticker | Order code |
|--|------------------------------------|-------------------------|
|         | | 123456 511024 - 0001 |
| Customized product label with your logo | | Custom sticker |
| Product label | | allsafe sticker |

► **Sample order code**

| | | | | |
|------------|---|-----------|---|-----------------|
| PAT 1000-2 | - | 2290-2520 | - | allsafe sticker |
|------------|---|-----------|---|-----------------|





KAT – Shoring beams custom-made

For various tracks.



KAT Combi

the original

KAT Airline

for Airline tracks

KAT SL

for garment transport

KAT AJS

for curtainsiders

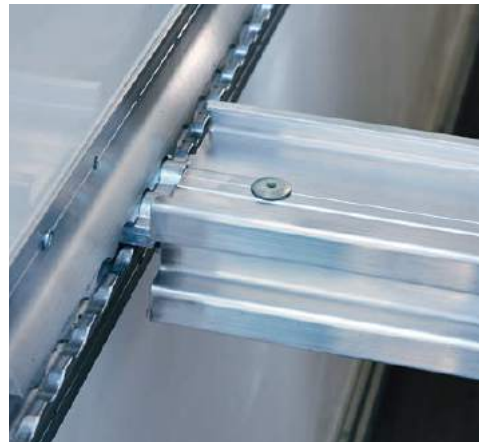
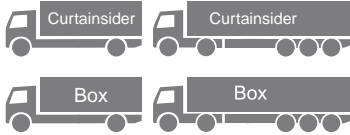

1.4 Faktor 4 KAT

KAT Combi

For combi tracks. For horizontal use.

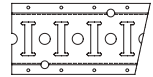

► Length

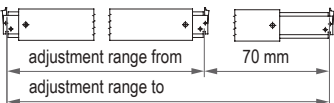
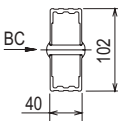
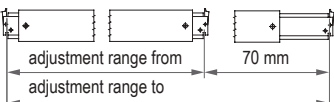
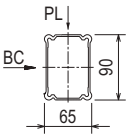
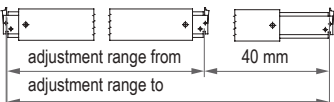
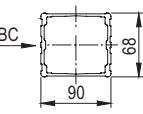

| 1 - Length / Adjustment range | 2 - Product identification sticker | Order code |
|--|--|---|
| <p>BC 900 daN: Internal dimension from min. 485 to max. 2510 mm – 70 mm adjustment range. Adjustment range from xxxx - xxxx needed by order <i>Warning: not suitable for double-deck loading</i> For standard width telescope also possible on both sides</p>  |  <p>BC 900</p> | <p>511303 KAT Combi 900 xxxx - xxxx mm</p> |
| <p>BC 1100 daN: Internal dimension from min. 485 to max. 2510 mm – 70 mm adjustment range. Adjustment range from xxxx - xxxx needed by order For standard width telescope also possible on both sides</p>  |  <p>PL 1000 BC 1100</p> | <p>511304 KAT Combi 1100 xxxx - xxxx mm</p> |
| <p>BC 2800 daN: Internal dimension from min. 650 to max. 2520 mm – 40 mm adjustment range. Adjustment range from xxxx - xxxx needed by order <i>Warning: not suitable for double-deck loading</i></p>  |  <p>BC 2800</p> | <p>511305 KAT Combi 2800 xxxx - xxxx mm</p> |

► Customized product identification sticker

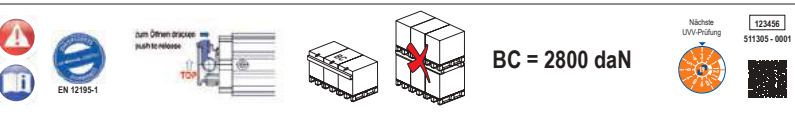
| ✓ | 2 - Product identification sticker | Order code |
|--|---|---|
|  <p>Customized product label with your logo</p> |  <p>Product label</p> | <p>Custom sticker allsafe sticker</p> |

► Sample order code

KAT Combi 2800 - 2480-2520 - allsafe sticker



KAT Combi Airline



Combi track approved. With Airline track for almost every application.



Length

| 1 - Length / Adjustment range | 2 - Product identification sticker | Order code |
|--|------------------------------------|---|
| <p>BC 1100 daN: Internal dimension from min. 650 to max. 2510 mm – 70 mm adjustment range. Adjustment range from xxxx - xxxx needed by order</p> <p>Airline track – BC 200 daN</p> | <p>PL 1000 BC 1100</p> | <p>511304 KAT Combi Airline 1100 xxxx - xxxx mm</p> |
| <p>BC 2800 daN: Internal dimension from min. 650 to max. 2520 mm – 40 mm adjustment range. Adjustment range from xxxx - xxxx needed by order</p> <p>Airline track – BC 250 daN</p> <p><i>Warning: not suitable for double-deck loading</i></p> | <p>BC 2800</p> | <p>511305 KAT Combi Airline 2800 xxxx - xxxx mm</p> |

Customized product identification sticker

| ✓ 1 - Customized product label | 2 - Product identification sticker | Order code |
|--|--|---|
| <p>Customized product label with your logo</p> | <p>BC = 2800 daN Airline-Schiene: LC 250 daN</p> | <p>Custom sticker allsafe sticker</p> |

Sample order code

KAT Combi Airline 2800 - 2480-2520 - allsafe sticker



1.4 Faktor 4 KAT

KAT Combi 800

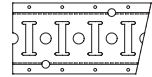

Blocking in combi tracks. Now spring-loaded for a tighter fit.







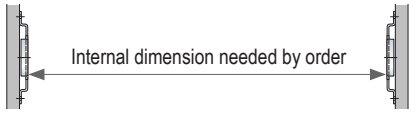
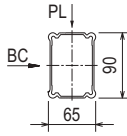



► Length

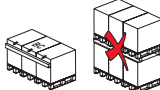

| 1 - Length | 2 - Product identification sticker | Order code |
|---|------------------------------------|--|
| <p>BC 800 daN: Adjustment lengths from min. 650 to max. 2510 mm.</p>  <p>Internal dimension needed by order</p>  | <p>BC 800</p> | <p>511302 KAT Combi 800 Internal dimension xxxx mm</p> |

► Customized product identification sticker

| ✓ | 2 - Product identification sticker | Order code |
|--|---|--|
|      <p>BC = 800 daN</p>    | <p>Customized product label with your logo</p> <p>Product label</p> | <p>Custom sticker</p> <p>allsafe sticker</p> |

► Sample order code

KAT Combi 800 - 2200 - allsafe sticker



Heads and insert made of aluminium – especially light-weight!

KAT Airline 800

Blocking in Airline tracks. Elastic force for sturdiness in box vehicles.

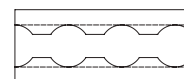





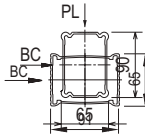

► Length



| 1 - Length | 2 - Product identification sticker | Order code |
|---|--|---|
| BC 800 daN: Adjustment lengths from min. 650 to max. 2510 mm. |  |  |
| | BC 800 | 511300 KAT Airline 800 Internal dimension xxxx mm |

► Customized product identification sticker

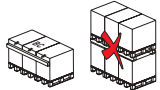
| ✓ | 2 - Product identification sticker | Order code |
|---|--|-----------------|
|        |  | |
| Customized product label with your logo | | Custom sticker |
| Product label | | allsafe sticker |

► Sample order code

| | | | | |
|-----------------|---|------|---|-----------------|
| KAT Airline 800 | - | 2480 | - | allsafe sticker |
|-----------------|---|------|---|-----------------|



1.4 Faktor 4 KAT

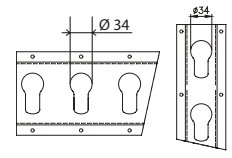

For keyhole tracks in garment transport and for double-deck loading.



► Length



| 1 - Length / Adjustment range | 2 - Product identification sticker | Order code |
|--|------------------------------------|--|
| <p>BC 900 daN: Internal dimension from min. 485 to max. 2510 mm – 70 mm adjustment range. Adjustment range from xxxx - xxxx needed by order</p> <p><i>Warning: not suitable for double-deck loading</i></p> | <p>BC 900</p> | <p>511309 KAT SL 900 xxxx - xxxx mm</p> |
| <p>BC 1100 daN: Internal dimension from min. 485 to max. 2510 mm – 70 mm adjustment range. Adjustment range from xxxx - xxxx needed by order</p> <p><i>For standard width telescope also possible on both sides</i></p> | <p>PL 1000 BC 1100</p> | <p>511310 KAT SL 1100 xxxx - xxxx mm</p> |
| <p>BC 2800 daN: Internal dimension from min. 650 to max. 2520 mm – 40 mm adjustment range. Adjustment range from xxxx - xxxx needed by order</p> <p><i>Warning: not suitable for double-deck loading</i></p> | <p>BC 2800</p> | <p>511311 KAT SL 2800 xxxx - xxxx mm</p> |

► Customized product identification sticker

| ✓ | 2 - Product identification sticker | Order code |
|--|------------------------------------|---|
| <p>Customized product label with your logo</p> | <p>Product label</p> | <p>Custom sticker allsafe sticker</p> |

► Sample order code

KAT SL 2800 - 2480-2520 - allsafe sticker





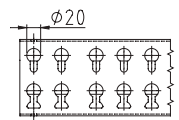

KAT AJS

For AJS lashing profiles. For horizontal use.



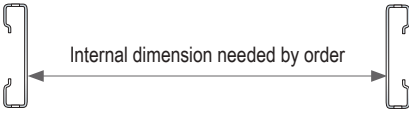
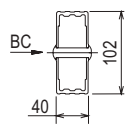

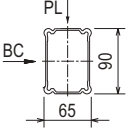
► Length

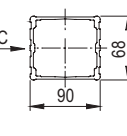

| 1 - Length | 2 - Product identification sticker | Order code |
|--|------------------------------------|---|
| <p>BC 900 daN: Adjustment lengths from min. 425 to max. 2510 mm – 70 mm adjustment range.</p>  <p>Internal dimension needed by order</p>  | BC 900 | <p>511306 KAT AJS 900 Internal dimension xxxx mm</p> |
| <p>BC 1100 daN: Adjustment lengths from min. 485 to max. 2510 mm – 70 mm adjustment range.</p>  <p>Internal dimension needed by order</p>  | BC 1100 | <p>511307 KAT AJS 1100 Internal dimension xxxx mm</p> |
| <p>BC 2800 daN: Adjustment lengths from min. 300 to max. 2500 mm – 40 mm adjustment range.</p>  <p>Internal dimension needed by order</p>  | BC 2800 | <p>511308 KAT AJS 2800 Internal dimension xxxx mm</p> |

► Customized product identification sticker

| ✓ | 2 - Product identification sticker | Order code |
|--|---|-----------------|
|  <p>Customized product label with your logo</p> | <p>BC = 900 daN</p>  | Custom sticker |
| Product label | | allsafe sticker |

► Sample order code

KAT AJS 900 - 2480 - allsafe sticker



Decking beams custom-made



For more loading volume and easy handling.



Classic

increases the loading capacity

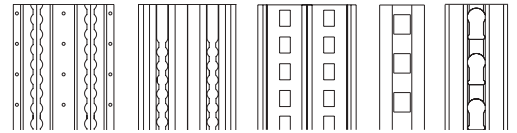

Heavy-duty

for even more loading capacity

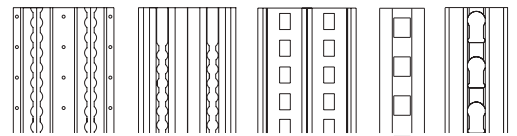

Space

optimal for low-height use

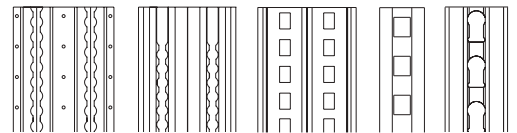

CTD

more loading volume
for curtainsiders





1.5 Faktor 4 Decking beams

Decking beams Classic

Positive locking in the double-deck tracks.







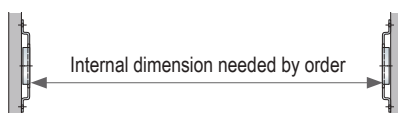
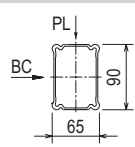



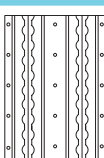

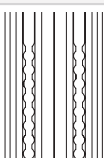

► Length



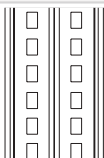





| 1 - Length | 2 - End pieces | 3 - Product identification sticker | Order code |
|---|--|---|---|
| PL 1000 daN BC 1100 daN Adjustment range from min. 650 to max. 2510 mm. |  |  | 512020 Decking beam Classic Internal dimension xxxx mm |

► End pieces

| ✓ | 2 - End pieces | 3 - Product identification sticker | Order code |
|---|----------------|--|----------------------|
|  | symmetric |  | ATD-I symmetric |
|  | asymmetrisch |  | ATD-I asymmetric |
| ATD-I | | Compatible with Airline | |
|  | symmetric |  | ATD-II symmetric |
|  | asymmetrisch |  | ATD-II asymmetric |
| ATD-II | | Compatible with Airline | |
|  | Type B |  | Schmitz Type B |
|  | Type V7 |  | Schmitz Type V7 |
| Schmitz | | Compatible with Schmitz tracks | |
|  | |  | STD |
| STD | | Compatible with tracks in steel swap bodies | |

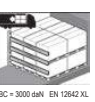
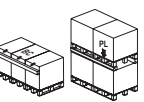
► Product identification sticker

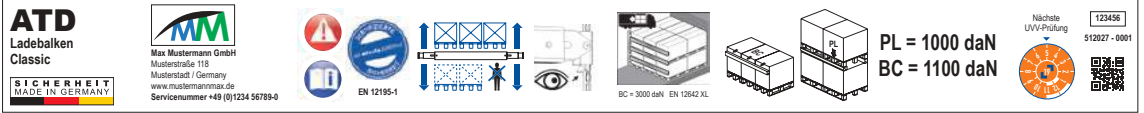
| ✓ | ✓ | 3 - Product identification sticker | Order code |
|--|---|--|-----------------|
|         | |  | Custom sticker |
| Customized product label with your logo | | | Custom sticker |
| Product label | | | allsafe sticker |

► Sample order code

| | | | | | | |
|----------------------|---|------|---|------------------|---|-----------------|
| Decking beam Classic | - | 2000 | - | ATD-I asymmetric | - | allsafe-sticker |
|----------------------|---|------|---|------------------|---|-----------------|



Decking beams Heavy-duty



For heaviest loads in double-deck loadings.



Length



| 1 - Length | 2 - End pieces | 3 - Product identification sticker | Order code |
|---|---|------------------------------------|--|
| PL 1350 daN BC 1100 daN Adjustment range from min. 650 to max. 2510 mm. | <p>Internal dimension needed by order</p> | | 512027 Decking beam Heavy-duty Internal dimension xxxx mm |

End pieces

| ✓ | 2 - End pieces | 3 - Product identification sticker | Order code |
|---------|---|------------------------------------|----------------------|
| | symmetric | | ATD-I symmetric |
| | asymmetrisch | | ATD-I asymmetric |
| ATD-I | Compatible with Airline | | |
| | symmetric | | ATD-II symmetric |
| | asymmetrisch | | ATD-II asymmetric |
| ATD-II | Compatible with Airline | | |
| | Type B | | Schmitz Type B |
| | Type V7 | | Schmitz Type V7 |
| Schmitz | Compatible with Schmitz tracks | | |
| | STD | | STD |
| | Compatible with tracks in steel swap bodies | | |

Product identification sticker

| ✓ | ✓ | 3 - Product identification sticker | Order code |
|---|---|------------------------------------|-----------------|
| | | | |
| Customized product label with your logo | | | Custom sticker |
| Product label | | | allsafe sticker |

Sample order code

Decking beam Heavy-duty - 2200 - ATD-II symmetric - Custom sticker

1.5 Faktor 4 Decking beams

Decking beams Space



Double-deck with maximum usable height.



Length



| 1 - Length | 2 - End pieces | 3 - Product identification sticker | Order code |
|--|----------------|------------------------------------|---|
| <p>PL 1000 daN BC 1100 daN</p> <p>Adjustment lengths from min. 650 to max. 2510 mm. Internal dimension needed by order</p> | | | <p>512028 Decking beam Space Internal dimension xxxx mm</p> |

End pieces

| ✓ | 2 - End pieces | 3 - Product identification sticker | Order code |
|---|-------------------|------------------------------------|------------------------------|
| | <p>asymmetric</p> | | <p>ATD-I asymmetric</p> |
| | <p>asymmetric</p> | | <p>ATD-II asymmetric</p> |
| | <p>Type B</p> | | <p>Schmitz Type B</p> |
| | <p>Type V7</p> | | <p>Schmitz Type V7</p> |
| | <p>STD</p> | | <p>STD</p> |

Product identification sticker

| ✓ | ✓ | 3 - Product identification sticker | Order code |
|---|---|------------------------------------|--|
| | | | <p>Customized product label with your logo</p> |
| | | | <p>Product label</p> |

Sample order code

| | | | | | | |
|--------------------|---|------|---|-------------------|---|-----------------|
| Decking beam Space | - | 1800 | - | ATD-II asymmetric | - | allsafe sticker |
|--------------------|---|------|---|-------------------|---|-----------------|



Decking beams CTD

Positive locking in the curtainsider.

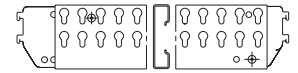

The max. loading capacity of this decking beam depends on the length of the side beams (x dimension).

„X“ Internal dimension / tolerance ± 1 mm

| Length CTD-side beam | Decking beam load capacity |
|-----------------------|----------------------------|
| X = 0 – 2499 mm | PL 400 kg |
| X = 2500 mm – 2999 mm | PL 300 kg |
| X = 3000 mm – 3500 mm | PL 200 kg |

► Load capacity PL



| 1 - Load capacity | 2 - Product identification sticker | Order code |
|---|------------------------------------|----------------------------|
| BC 800 daN Adjustment range from 2210 to 2530 mm. | | Internal dimension xxxx mm |
| PL 400 kg per Europallet space | | 510800-10 |
| PL 300 kg per Europallet space | | 510800-11 |
| PL 200 kg per Europallet space | | 510800-12 |

► Product identification sticker

| ✓ | 2 - Product identification sticker | Order code |
|---|--|-----------------|
| | Customized product label with your logo Product label | Custom sticker |
| | | allsafe sticker |

► Sample order code

510800-10 - allsafe sticker

